



ENGINEERING – AT ITS BEST.

Professional competence, reliability & safety



KLINGER ENGINEERING

Engineering services for sealed connections

Organisationally, KLINGER Engineering is part of KLINGER Kempchen GmbH in Oberhausen (Germany) and offers a broad range of services relating to gaskets and gasket joints for the individual KLINGER companies and their international KLINGER Group customers.

The KLINGER Engineering team is made up of engineers, technicians and technical experts from the most varied of fields. In their own unique way, each team member combines extensive technical knowledge and practical experiences from a variety of industry branches. Together, the team have decades of experience from a vast number of disciplines such as refinery technology, chemical technology, nuclear technology, designing pipes and apparatus, pipe and apparatus construction, chemical apparatus technology, welding technology, material technology, corrosion and metallurgy, power plant engineering, compressor and turbine construction and from specific subject areas such as damage investigations and reliability management.



EXPERTISE & EXPERIENCE

At KLINGER Engineering, our top priority is guaranteeing system safety and reliability. Regardless of whether you are transporting liquids or gases: we see our task as ensuring that these media stay exactly where they belong. Our engineering services guarantee that your operation will be reliable and safe, without leakages and consequential damage, or damage to materials. Our innovative and highly modern methods of designing and calculating gasket joints are based on our specialist knowledge and experience. By developing and applying a vast number of software solutions tailored to the specific requirements of the respective industries, we can safeguard and guarantee the reliable function of gasket joints.

ENGINEERING SERVICES

DESIGNING SEALED CONNECTIONS AND SPECIAL GASKETS

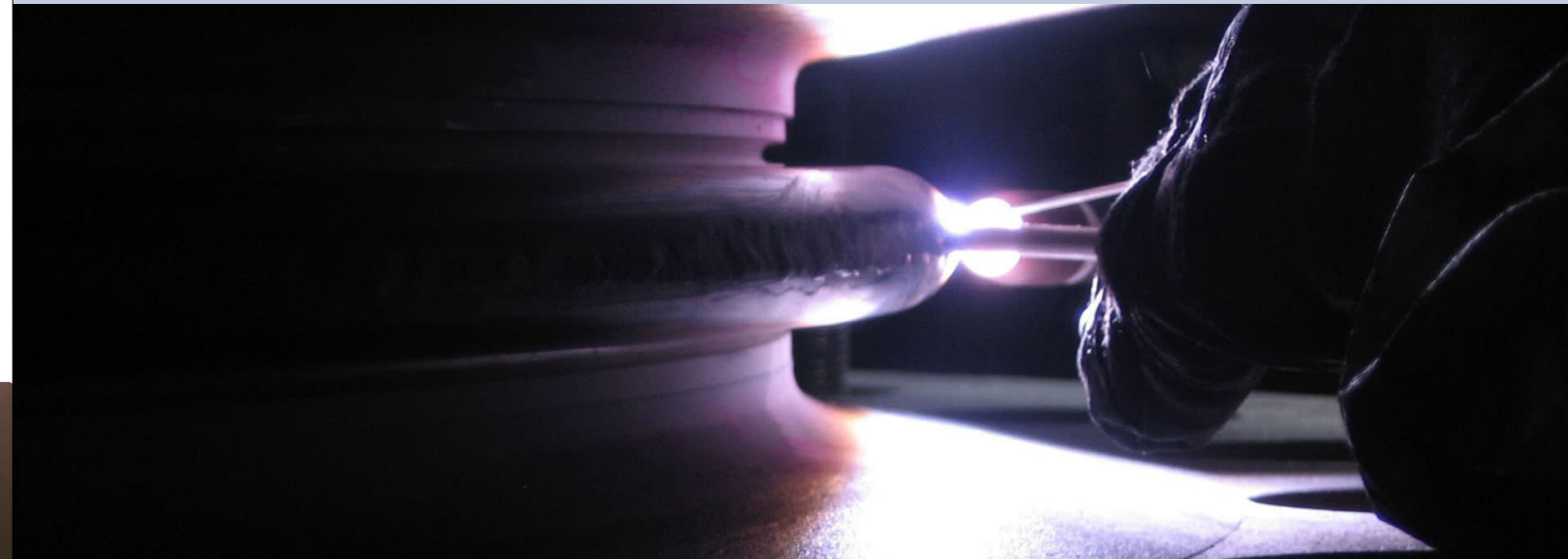

Experience and knowledge of seals and sealing materials

The designing, construction, calculation and specifications of gaskets and sealed connections require a great deal of experience and knowledge about how gaskets and sealing materials behave under various operating conditions. We can offer you a complete service, starting with a preselection of suitable materials and suitable types of gaskets, to the design and specifications of the required components, right up to coordinating with the corresponding third party organisation (notified body) or ASME inspection agencies.

DESIGNING SEALED CONNECTIONS FOR HIGH TEMPERATURE APPLICATIONS

When does a high temperature range start?

Developing new processes in various industry branches requires greater and greater operating temperatures and pressures. The deployment and use of standard gaskets and standard gasket technology materials have reached their limit by maximum 500 °C in terms of function and durability. Here, we are happy for you to make use of our expertise when it comes to using materials and applying calculation methods tailored to high temperatures. At the customer's request, we plan and carry out the corresponding component tests in the relevant application temperature to verify the effectiveness of the designs and confirm the durability of the gaskets.

DESIGNING AND CALCULATING WELD-RING GASKETS

Tightness and reliability required

Weld-ring gaskets are always used when widely varying temperatures prevent the use of a different static gasket, where leakage would lead operational interruption, or where an increased degree of leak tightness and reliability is required because of the hazardous nature of the medium. Weld-ring gaskets are available in a range of types and materials, as well as in combination with auxiliary gaskets. The type of weld-ring gasket used within a gasket joint depends on the different parameters and requirements. Irrespective from the selected weld-ring profile, review of the flange and gasket design by the gasket manufacturer is highly recommended.

IN ADDITION TO OUR NUMEROUS COMPUTATIONAL SOLUTIONS AND DESIGNS, WE ALSO OFFER:

- » On-site support/consulting before and during installation
- » Practical realisation of disassembly and welding
- » Quality management all around the manufacturing process of gasket connections

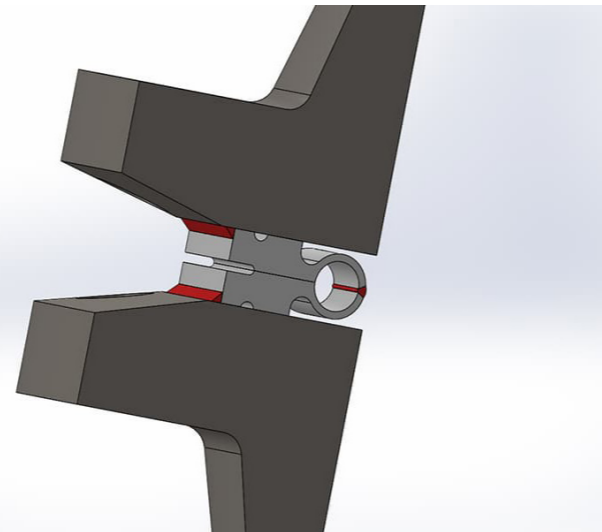

DESIGN AND CALCULATION OF METALLIC GASKETS

For hardly measurable, smallest leakage rates

Metallic gaskets are present in a large variety of geometric shapes and materials in industry and in sealing technology. The field of application of metallic gaskets begins where soft material gaskets made of fibres, graphite and elastomers no longer work reliably enough at the operating pressure or temperature to be sealed or where there is a risk of gasket failure. Metallic gasket constructions have the potential to become really „tight“, whereby „tight“ at this point may be understood to mean „no longer measurable ($q_L < 10^{-10} \text{ mbar} \cdot \text{l} \cdot \text{s}^{-1}$)“ small leakage rates.

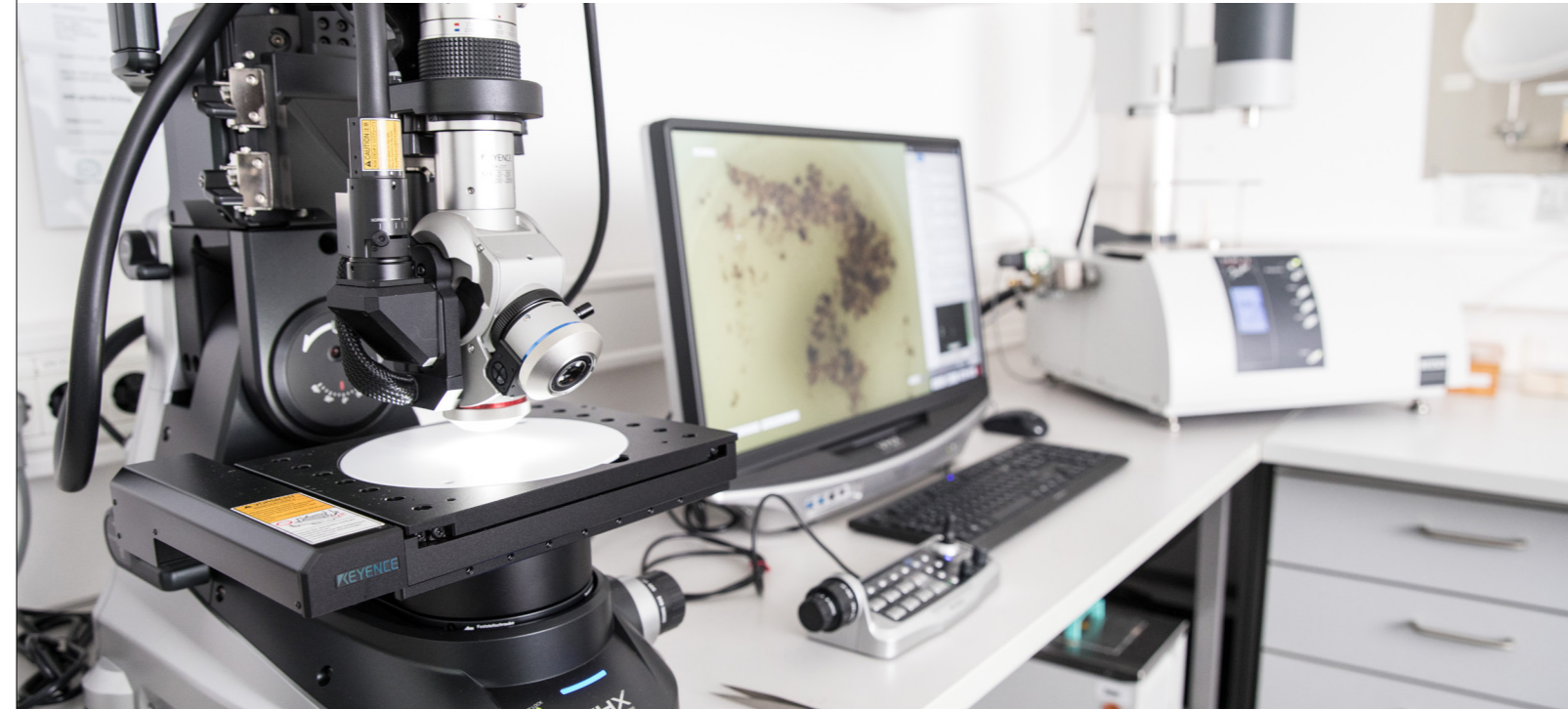

Calculation and design is our know-how

KLINGER Engineering has provided a technical solution for the design of sealing connections with metallic bevelled gaskets for all metallic gaskets available on the market. Due to our experience, we are able to calculate and evaluate almost any special solution using the most modern calculation methods. If, in addition to strength, tightness is also to be considered, the calculation of flanged joints is best carried out according to DIN EN 1591-1 or, somewhat more complex, in combination with additional or supporting numerical simulation (FEA).



3D DESIGN AND FINITE ELEMENT ANALYSIS

Verification of damage theories

If you have run out of analytical calculation method options or if the component geometry or operating modes are very complex, we are also capable of helping you further. Thanks to our expertise, we can offer you three-dimensional modelling with subsequent linear or non-linear finite element simulation.

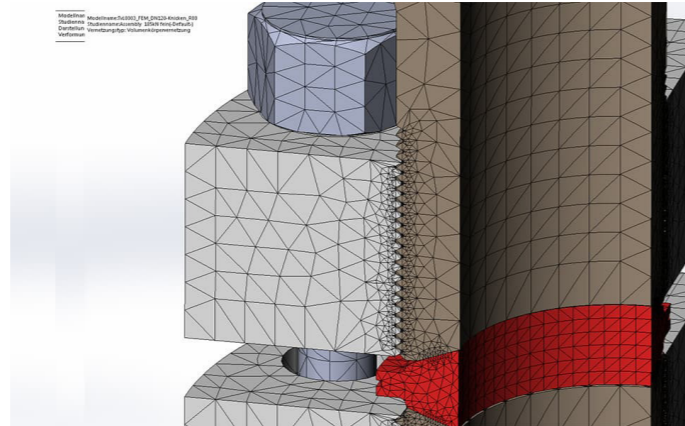

3D DESIGN WITH SUBSEQUENT FEM SIMULATION

FEM analysis is a tool which is frequently used to verify damage theories, particularly as part of damage investigations.

IN THIS CONTEXT, WE CAN OFFER YOU:

- » for gaskets at the main power connection / metal to metal contact type
- » for flange and sealed connections of all kinds
- » for metal gaskets such as double-cone gaskets, weld-ring gaskets, ringjoint-gaskets or lens gaskets
- » to examine custom structures which deviate from the standard

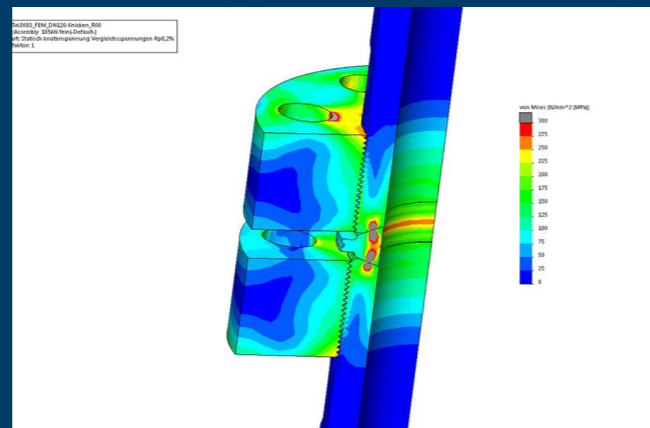

PIPE STATIC ANALYSES AND CALCULATIONS

Determining section loads for flange joints

Pipe static analyses and the design and calculation of flanged joints are coming together more and more frequently. If before now, pipe static analysis was only used in planning projects to check pipe plans, it will play a much more important role in the future. It may be true that a flange calculation can also be carried out with a few conservative assumptions for additional external loads (e.g. DIN 1092), but the problem itself lies in these assumptions especially.

Under certain circumstances, component load designs which are based on an assumption can lead to the uneconomical oversizing of individual equipment components. We primarily focus on determining section loads for flange joints which result from operating existing pipes on the respective equipment. In this framework, we can offer our customers the creation and implementation of pipe static analyses with the programming system ROHR.

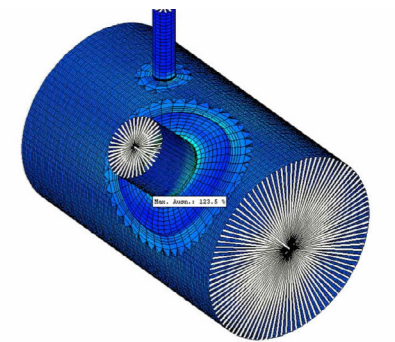

PIPE CLASS DESIGN AND MAINTENANCE, MATERIAL GUIDELINES AND SPECIFICATIONS

Basic engineering in classical unit construction

Pipe classes represent basic engineering in classical unit construction and the applied material designations, standards and delivery conditions must be reviewed and updated from time to time. The increased leak tightness requirements frequently require parts or pipe components to be optimised. We are pleased to announce our new “KLINGER Piping” pipe class database which will be available in the near future.



TURNAROUND ENGINEERING

Pipe planning & process technology

System down-time is essential for cleaning and maintaining equipment, repairing and replacing pipes, valves and control devices. There are a large number of participating specialist trades, labourers, suppliers, service providers and departments to coordinate each time the system is shut down. The key to successful down-time is making plans at an early stage and in as thorough a way as possible. But we are also here to assist you at any time for short-term downtime or for support during ongoing down-time and shutdowns.

MANAGEMENT CONCEPTS

Training of the flange fitters & definition of assembly standards

The optimisation of flanged joints within pipe classes or on apparatus flanged joints is the only correct way to ensure a leak-free flange connection without compromise. But a calculation, screw and high-quality gasket alone still cannot guarantee reliable leak tightness. This can only be produced when the flange joint is being assembled, and only when the flanges, gaskets and bolts which have already been included in the calculation are used. Here, we must combine theory and practice and use suitable assembly specifications and strategies to really “give power to the bolts”, which the gasket needs to be able to operate safely. At the same time, we must set up and apply rules for targeted and effective quality management. In this connection, our offer also includes the preparation of management concepts and documentation tools in addition to installation standards and instructions.



RELIABILITY CONCEPTS FOR EXISTING EQUIPMENT, NEW CONSTRUCTIONS AND THE OPTIMISATION OF PRESSURE EQUIPMENT

To seal heat exchangers

Aside from pumps and pipes, heat exchangers and air cooling devices are the centrepieces of the process systems for many operations. Safe, economical operations are soon put in danger due to heat exchangers which are not leaktight or which are working with poor efficiency. The maintenance costs for repairs or sealing leaks shoot up; losses in contribution margins due to unplanned downtime lead to poor profits. At the same time, citizens living in direct proximity to undesired emissions have a higher level of awareness, which often guarantees complaints to authorities or companies.

IN THIS CONTEXT, WE CAN OFFER YOU THE FOLLOWING SERVICES:

- » The calculation of individual equipment flanged joints right up to the systematic calculation of whole apparatuses.
- » The handling of calculation projects for existing groups of equipment or system areas.
- » The systematic investigation of leakage and tightness problems.
- » The optimisation of existing equipment flange connections.

DAMAGE INVESTIGATION

DAMAGE AND INCIDENT INVESTIGATIONS

Systematic measures to identify causes

In spite of careful construction, high-quality gaskets and an increasing assembly quality, and even when complying with the prescribed mode of operation, it is not always possible to prevent flange joints from failing. The well-known guidelines in particular have a few weaknesses.

These leaky flange joints often result in a massive economic loss due to the undesired leakage of media and the production down-time which follows in most cases. Corrective measures can only be introduced in a targeted manner if the cause of damage has been clarified by way of the corresponding investigations. The same or similar undesired incidents can be eliminated safely in the future.

FINAL INVESTIGATION REPORT

At the end, we will prepare an investigation report together with you, which states the direct causes of the leakage. All investigations are subject to the most stringent confidentiality..



ON-SITE DAMAGE ASSESSMENT

Prevent hazards & safeguard

If damage occurs, the top priority is to continue to prevent hazards or to safeguard the environment and contain further risks to humans and the environment. The second stage must be to plan damage analysis and to define the type and scope of the investigation stages. Here, it is highly important to secure evidence at the area of damage. If proof or information is not adequately collected or unintentionally destroyed, the probability of being able to conduct a fact-based analysis is reduced and the degree of presumptive analysis increases. However, only a fact-based analysis gives you the possibility of reliably eliminating errors and weak points in processes and structures in the future.



IN THIS CONTEXT, WE CAN OFFER YOU THE FOLLOWING SERVICES:

- » Analysis of the flange connection on site after the leakage has occurred.
- » Root cause analysis: How was the flanged joint fitted? Are there signs of a lack of care during assembly? Were the correct components used?
- » Support in disassembling leaky flanged joints at your premises.
- » Exact documentation of findings when the flanged joint is opened.
- » Securing, labelling and packing the used components and transporting them to our labs for investigation.
- » Survey and analysis of the secured components in our chemical and physical labs for the effective identification of any systematic errors.

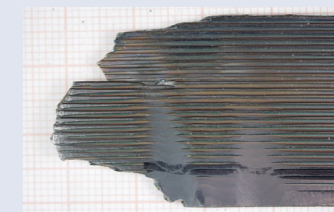
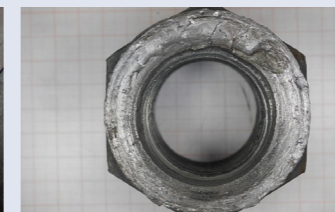

ROOT CAUSE ANALYSIS & LOGIC TREE ANALYSIS

Damage analysis

The type and scope of damage analysis is mainly aligned towards the severity and importance of the incident concerned. Root cause analysis (RCA) is a common method of identifying and rectifying causes of error or problems in science and engineering. RCA technology is implemented regularly, particularly in the chemical or petrochemical industry, or in the analysis of accidents. The fundamental idea behind all RCA methods is firstly the precise description of the problem or incident, the theoretical listing of possible causes and the systematic testing of the route to the error. Here, technical facts and witness statements play an important role, as does the retrospective simulation of the incident.

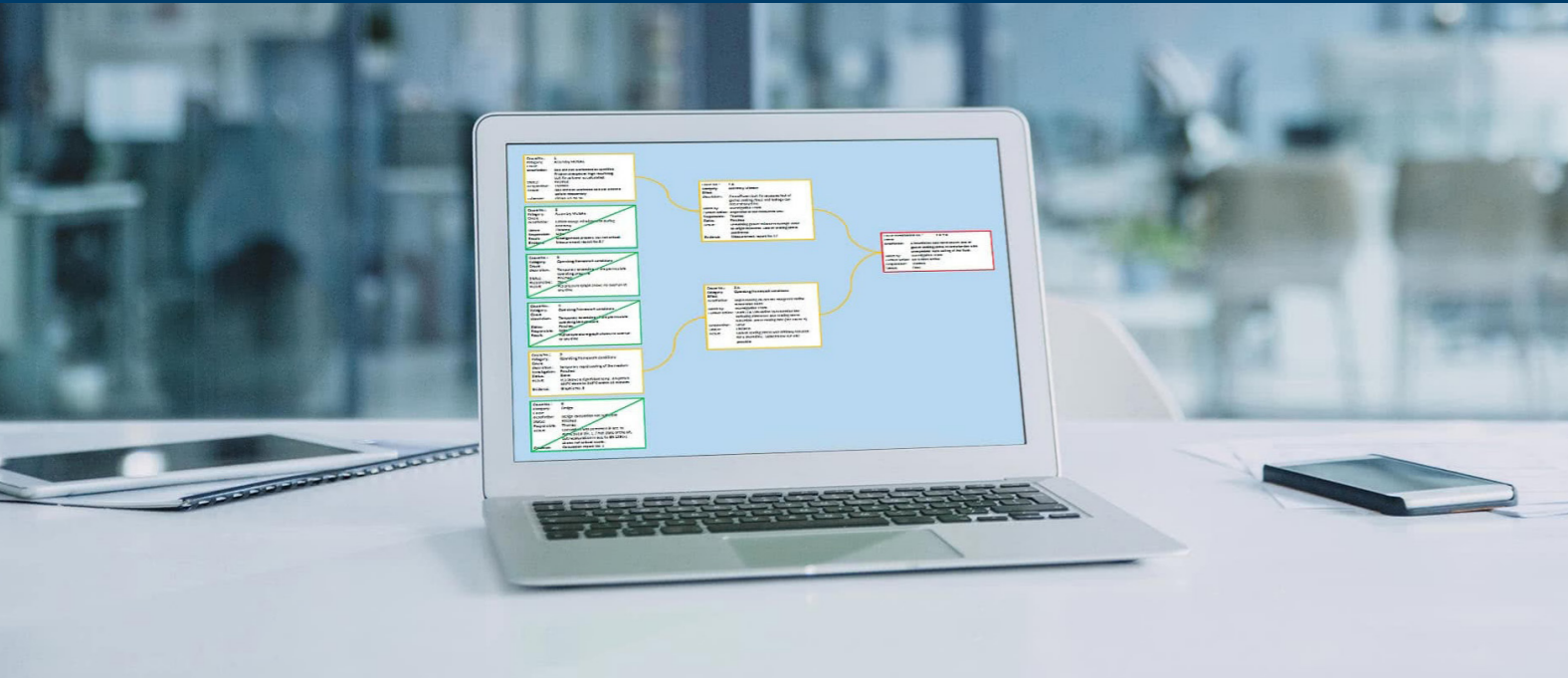

As well as the correct questioning technique, the auxiliary tools of a good RCA are the creation of a timeline from the past up until the incident occurrence, the differentiation between the root cause and other causal factors, and the creation of a causal diagram (cause and effect logic tree) to clarify the relationship between the root cause and the incident.

Die Hilfswerkzeuge einer guten RCA sind neben den richtigen Fragetechniken, die Erstellung eines Zeitplanes (Timeline) von der Vergangenheit bis zum Eintreten des Ereignisses, die Unterscheidung zwischen Grundursache und anderen kausalen Faktoren sowie die Erstellung eines Kausaldiagrammes (Cause And Effect Logic Tree) zur Verdeutlichung des Zusammenhangs zwischen Grundursache und Ereignis.

LABORATORY SERVICES

LABORATORY SERVICES AND INVESTIGATIONS

Quality assurance regarding our materials

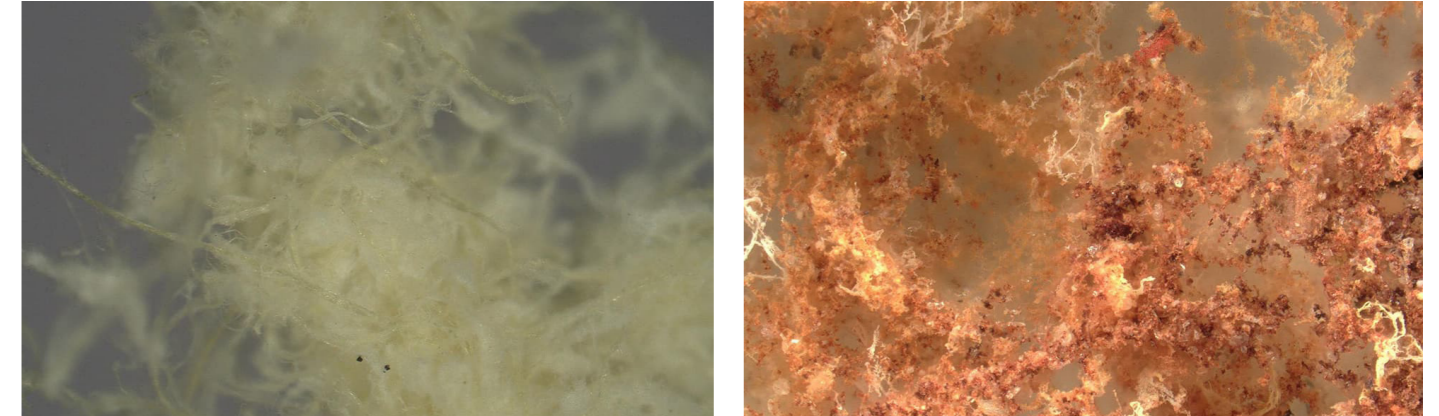

Our chemical and physical labs are the cornerstones of our company when it comes to quality assurance regarding our materials and finished products. Everything that cannot be evaluated by way of a simple visual inspection is taken through our labs regularly to guarantee a consistently high quality. Newly developed products, materials and material combinations are put through their paces. Particularly chemical resistance tests are vastly important and are also frequently carried out at the customer's request.

To create our gasket profiles, the gasket parameters are tested repeatedly according to DIN EN 13555 and data sheets are updated accordingly in the event of any changes. A good lab is also highly necessary for detailed damage analysis.



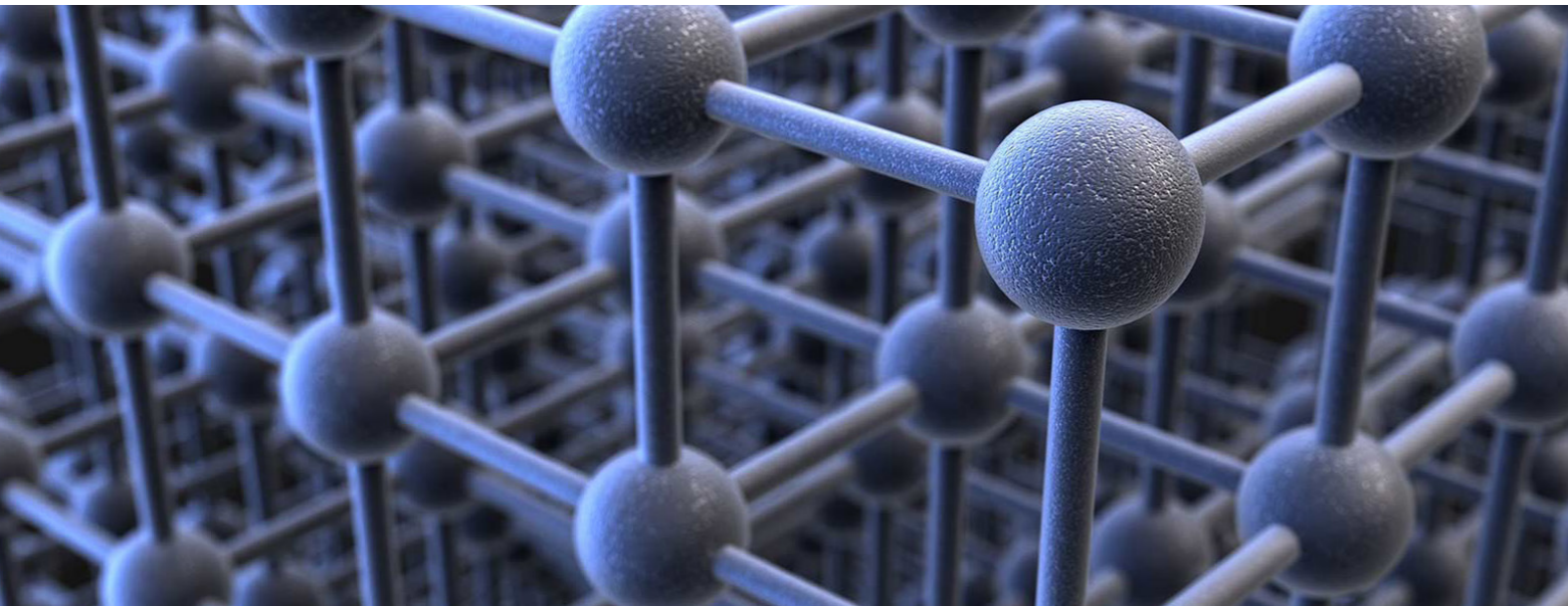

METALLURGICAL INVESTIGATIONS

Find and identify causes

For metal gaskets, particularly weld-ring gaskets, damage frequently occurs in the form of cracks. By investigating the microstructure of metal materials, we can draw conclusions about the manufacturing processes or thermal treatment, or the physical and chemical properties. To limit the causes of crack formation or to evaluate the quality of a welds, we make use of qualified and accredited test labs from our area. As part of the investigation, we forward the damaged parts to the relevant labs and organise the handling of the investigations from the taking of samples right up to the coordinated test report.

We carry out more minor investigations such as hardness measurements or topological investigations of damaged sealing elements and surfaces in our own labs.

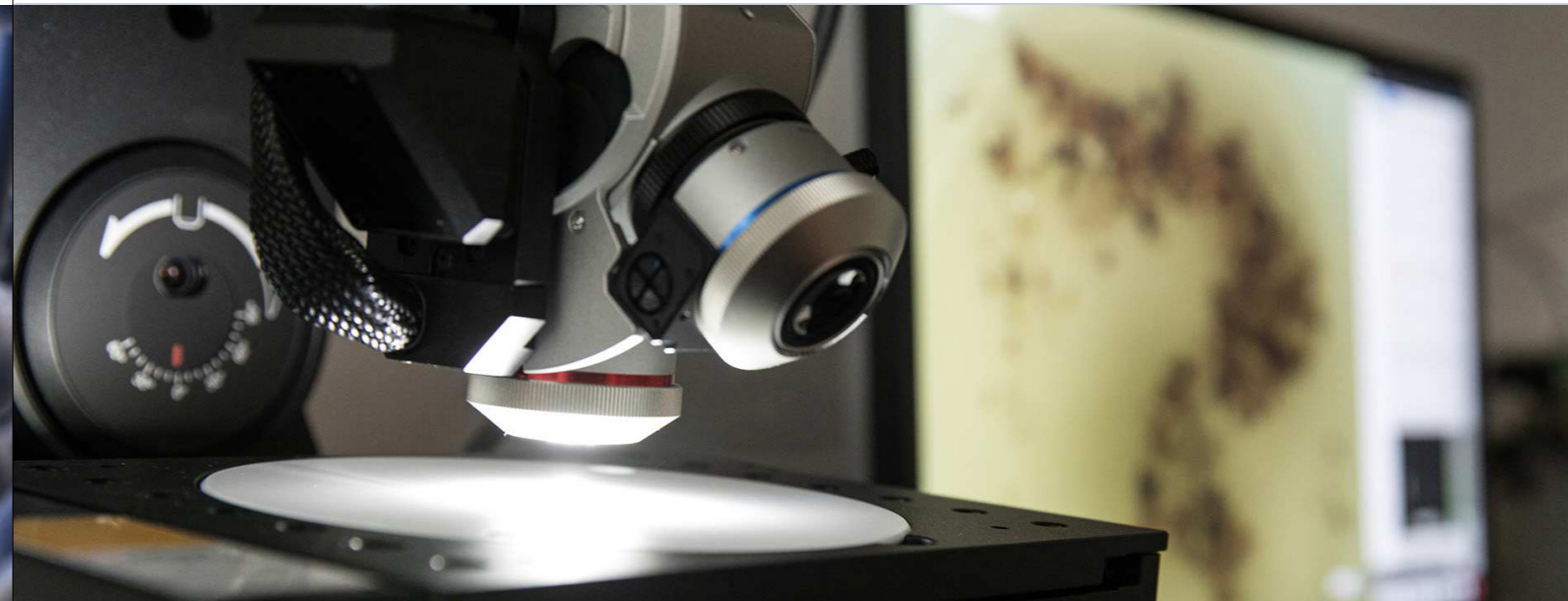
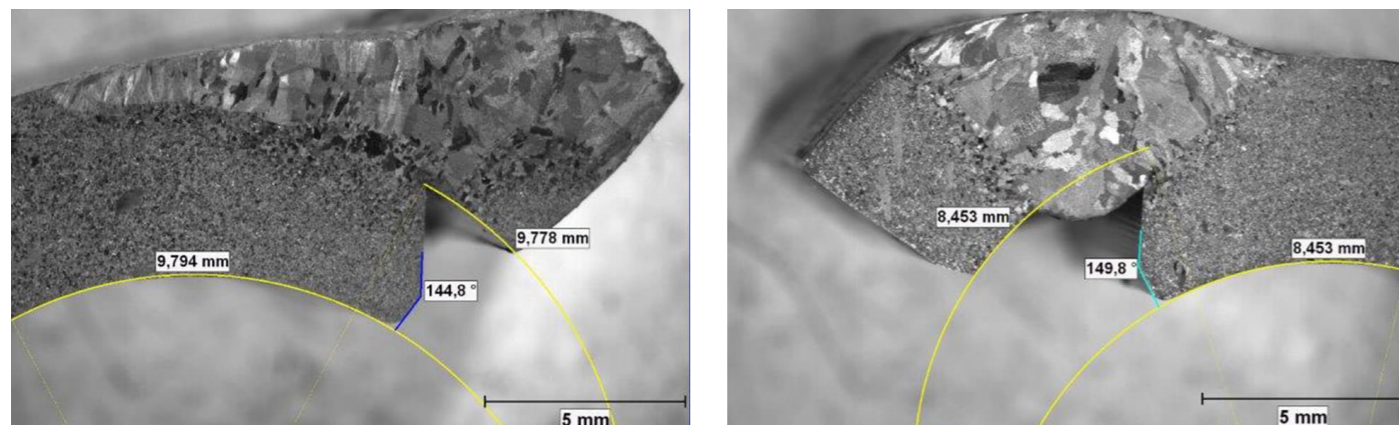

ANALYSIS OF GASKET MATERIALS

Analysis methods and devices

When examining some damage cases, the interaction between the gasket materials used, the operating medium and the application temperatures are the focus, in rarer cases, the quality of the supplied starting materials for producing the gasket is also relevant. In our chemical lab, we use state of the art analysis methods and devices to characterise, catalogue and archive individual materials.

Within a damage analysis process, you don't just have access to the corresponding analysis methods and devices; you also have access to a wide range of material information to assess the damage.





TYPE EXAMINATIONS, TA LUFT TESTS OR BLOW-OUT RESISTANCE

Achieve, structure & defining

No matter which type you are looking to achieve, structure you prefer or gasket you use: our lab is happy to help you with evaluating and carrying out type examinations, TA Luft tests or tests to establish the blow-out resistance. In our bolting technology centre, we implant even complex geometry components into our vacuum chambers to help you in defining the effective overall leakage.

DETERMINING GASKET PARAMETERS

According to DIN EN 13555

Compared to all market competitors, our physical lab has the most varied of gasket test rig equipment. From ambient temperature up to 900 °C, we are able to determine individual gasket parameters or gasket parameters in accordance to DIN EN 13555 and other guidelines and requirements. We can carry out leakage measurements in test temperatures of up to 600 °C and at a maximum test pressure of 160 bar. Higher test pressure stages (max. 500 bar He) on request. We are happy to support and assist you and precisely determine all the gasket parameters that you require for your application – for any type of gasket material and regardless of the manufacturer.

All public gasket parameters are formatted and entered into our gasket database. Within the gasket database, you can select the gasket parameters for your gasket and display the data in tabular and graphical form. The selected data can be downloaded as an XML file or PDF at any time.

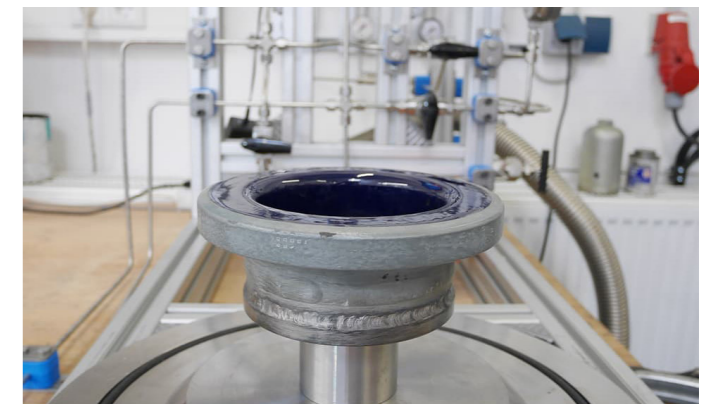

PRACTICAL DAMAGE ANALYSIS EXCELLENT

Knowledge and expertise in particular

Many customers make use of our excellent knowledge and expertise in particular in the field of damage investigations to prove the actual causes after an incident. This means that the labs also play a central role within the damage analysis. In the case of damage, we are happy to offer every customer our support.

In our bolting technology centre, we can assemble diverse flange joints and subject them to a leakage measurement. On one hand, to test the behaviour of gaskets independently of the standardised test rig, on the other hand, to simulate specific damage theories in the event of damage, for example, by reproducing the specific incorrect assembly to confirm the damage theory and origin in the findings.



LABORATORY EQUIPMENT FEATURES

CHEMICAL LABORATORY

- » Hardness test device
- » Digital microscope with zoom lenses
- » Test equipment for anion evidence
- » Thermal analysis
- » Muffle furnaces
- » Lab furnaces
- » Various lab equipment

PHYSICAL LABORATORY

- » Test rigs to determine gasket parameters individual
- » Leakage detectors
- » 3D-strip light scanner
- » Fuji-prescale scanner
- » Universal heating chamber
- » Various small appliances

BOLTING TECHNOLOGY CENTRE

- » Vacuum chamber V
- » Leakage detectors
- » MAXIMATOR compressor unit
- » Profile recording equipment



EQUIPMENT PROCUREMENT SERVICES



KLINGER EPSfull or KLINGER EPSsmart

The KLINGER Engineering Team is already known to you as a competent and flexible partner in the field of problem solving in case of leakages. While we love the challenge of finding solutions for leakages, wouldn't it make more sense to prevent leakages in advance? Take advantage of our complete and in-depth expertise in the construction and manufacture of pressured equipments! We are not only familiar with the technical and constructional problems that occur especially in borderline areas, but also with their technical solutions. Therefore, we divide our service into two competences: KLINGER EPSfull and KLINGER EPSsmart.

KLINGER EPSfull or KLINGER EPSsmart – Comparison

KLINGER EPSfull:

You need a new equipment or storage tank? No problem! We will gladly deliver it to the installation site.

KLINGER EPSsmart:

We place our complete and in-depth specialist knowledge at your disposal for the request, construction and manufacture of equipment and storage tanks.

You decide which alternative is the best solution for you. Whichever service you choose: At any time you have complete transparency in drawings and documents, prices and delivery times. We place the highest demands on our service and offer the greatest flexibility in combination with maximum transparency, clear results without surprises, as well as compliance with all requirements and schedule plannings. The extension of our service to the field of equipment and storage tanks makes us an efficient partner of the industry.

PERFORMANCE COMPARISON

PRE-DIMENSIONING

	KLINGER EPSfull	KLINGER EPSsmart
Selection of building regulations (Design Code)	✓	✓
Pre-selection of main materials and alternatives	✓	✓
Creation of inquiry specification based on customer requirement	✓	✓
Pre-dimensioning and sketching (shell, nozzles, flanges, tube sheet, stability etc.)	✓	X
Corrosion analysis and service life evaluation	✓	X
Consideration of special load cases	✓	X

COMMERCIAL PROCESSING

Selection of potential manufacturers / producers in consultation with customers	✓	✓
Inquiry of the equipment at selected producers / manufacturers	✓	✓
Inquiry support in case of queries from manufacturers / producers	✓	✓
Offer evaluation / offer comparison	✓	✓
Transparent offer discussion with customers	✓	✓
Award / contract negotiation	✓	X
Ordering / commissioning of the equipment (Manufacturer in the sense of the PED 2014/68/EU)	✓	X

TECHNICAL PROCESSING

Design support by KLINGER Engineering (queries, change management, deadline tracking)	✓	✓
Design Review KLINGER Engineering (especially for gasket resp. flange connections; review of selected main components)	✓	✓
Design Review KLINGER Engineering (all gasket resp. flange connections; review of all main components)	✓	X
Preparation of design documents for preliminary review (NoBo/ASME Inspection Agency)	✓	X
Coordination / monitoring of the preliminary examination (NoBo/ASME Inspection Agency)	✓	X
Approval of production documents together with customers	✓	✓
Introduction Material procurement, testing and production	✓	X
Progress reports and deadline tracking	✓	✓
Production reports and quality assurance	✓	✓
Acceptance coordination	✓	X
Delivery and unloading	✓	X
Installation, mounting and assembly	Upon request	X

PROGRAMME SYSTEM KLINGER BABSY

BABSY – VESSEL & APPARATUS CONSTRUCTION SYSTEM

The programme system KLINGER BABSy is a modular calculation tool for the fast and effective calculation of pressure and temperature-stressed components for the manufacture and repair of piping and apparatus. The name BABSy is composed of Behälter- und Apparate Bau System (tank and apparatus construction system) and currently offers calculation modules for the following regulations:

- » AD 2000 B series and S series
- » DIN EN 13480 Design of metallic piping
- » DIN EN 13445 Unfired pressure vessels
- » BS5500 British Standard
- » ASME Code Section VIII/Div. 1
- » ASME Code Section VIII/Div. 2
- » Stoomwezen

Additionally, further modules (in some cases individual modules) are available for a wide variety of uses.

PROGRAMME USE

It is anticipated that as of the 3rd quarter of 2021 we will enable interested existing customers access * to the programme system in the form of a singleplace installation, in order to support them and to facilitate their work on and with pressure-bearing parts. The purchase price as well as an annual service lump sum will be based partly on the turnover level of the last few years.

Development

As a provider of engineering services, a modular programme system such as KLINGER BABSy offers us the scope to develop optimised calculation algorithms or, if needed, new calculation solutions for our customers.

Sealing connections are our core business. Therefore, we are working intensively on a new version of DIN EN 1591-1, which already finds itself largely on the home straight. Our main focus is on the development of tools for the calculational strength and tightness proof for enamelled flange connections, flange connections with inliner or coatings.

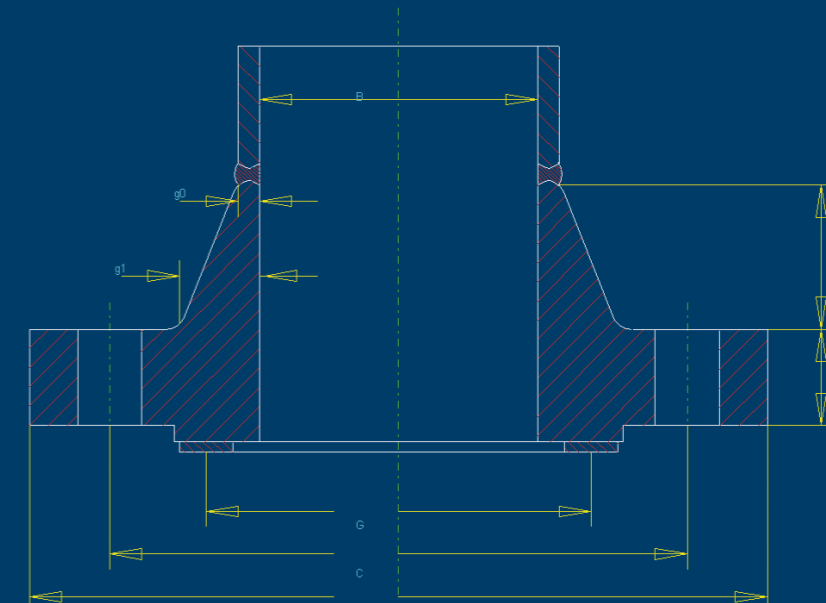
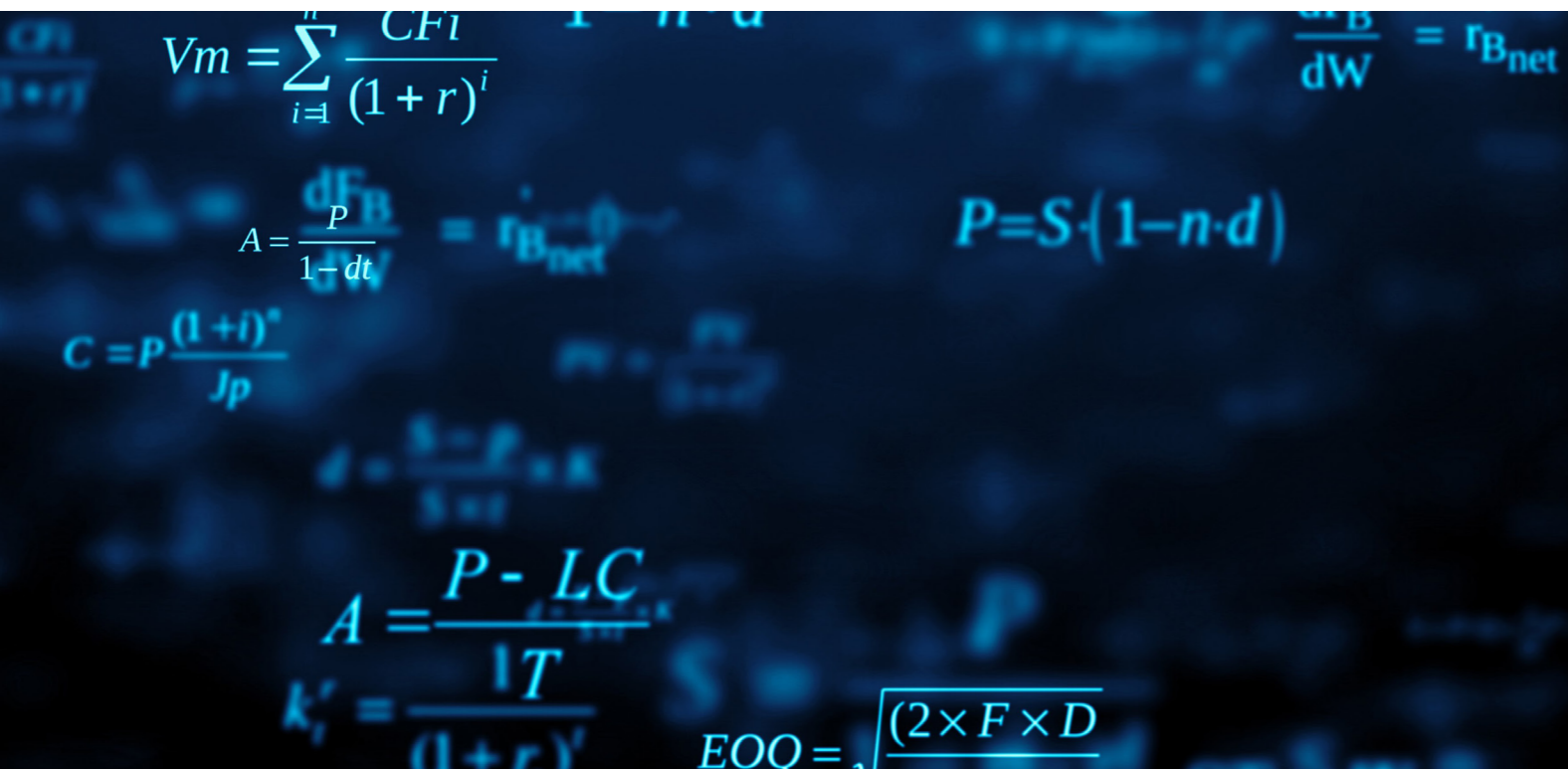

* right to acquire and use the programme system KLINGER BABSy for all existing customers of KLINGER Kempchen GmbH with customer number received before 31/12/2020.



2021 Edition | Printing and typesetting errors excepted

KLINGER Kempchen GmbH
Im Waldteich 21 » 46147 Oberhausen
T: +49 208 8482-0 » F: +49 208 8482-285
engineering@klinger-kempchen.de